

A robust and easy to install enclosure for electrical and other services

- A range of standard sizes from 50x50mm to 300x300mm
- Any size, or profile, can be manufactured
- Rapid installation: each length comes with a threaded connector - no need for nuts
- Rapid installation: the quick release lid runs the full length of the trunking
- Rapid installation: a full range of accessories eliminates on site fabrication

● Optional features include:

- weatherproof trunking
- partitions to give multiple compartments
- choice of finish, of galvanised steel, white, stainless steel and others to order

● Made to comply with BS4678 part 1

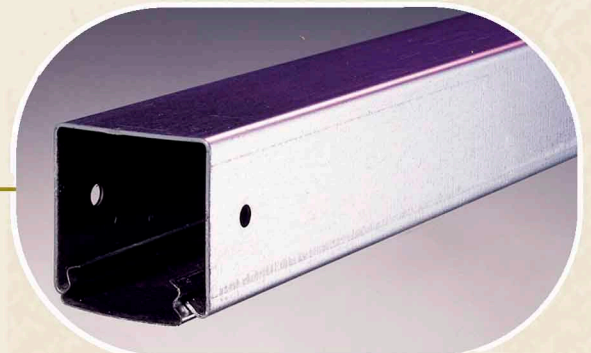
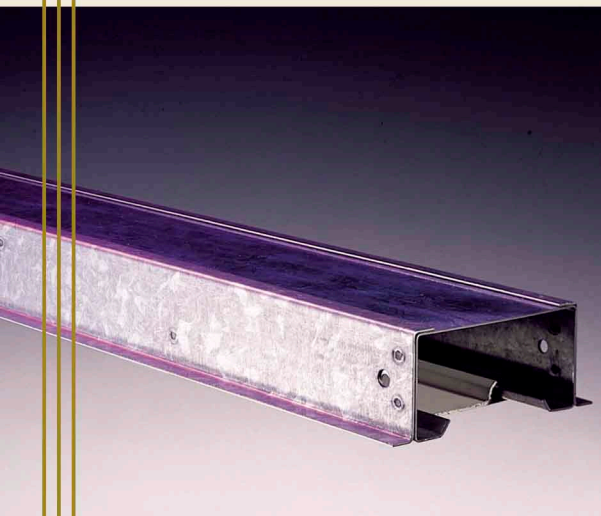
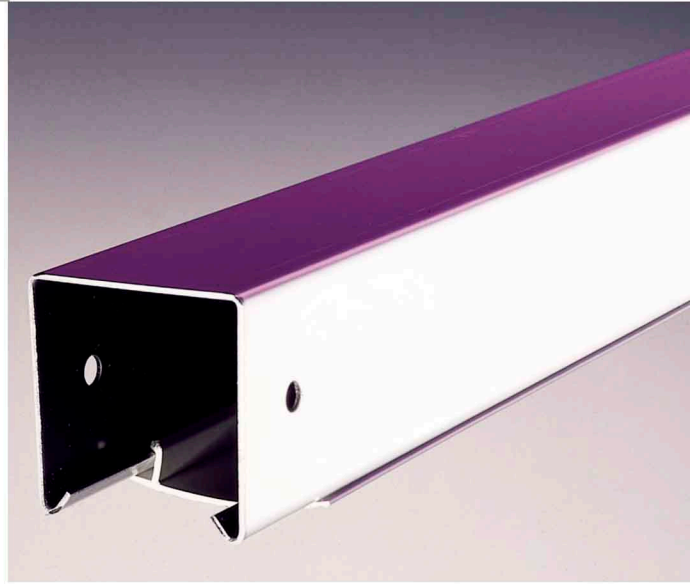

What options are available?

1) Standard profiles

Surface trunking

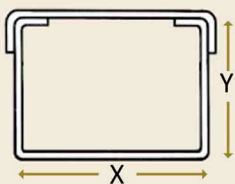

Ref C type

- Available for any value of X and Y
- A range of stocked sizes
- Available in 2 or 3m lengths

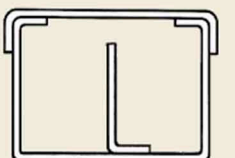

Ref C type - multiple compartment

- Available for any value of X and Y
- Any number of compartments
- Compartments of equal or unequal size

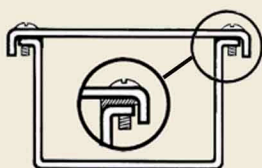

Ref E type

- Available for any value of X and Y
- Lid and all joints fitted with gasket for weatherproof seal

Lighting trunking

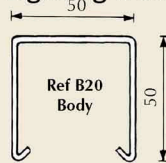

Ref B20 Body



Ref B22 Plastic Lid

Ref B23 Steel Lid

- Available for any value of X and Y
- Ranges B, F and L are available ex stock in 3m lengths

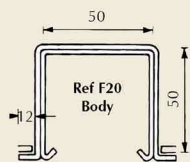

Ref F20 Body



Ref F22 Plastic Lid

- Available in ranges B, F and L with a choice of a steel or plastic clip in lid. For all other sizes a steel clip in lid is provided

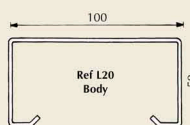

Ref L20 Body

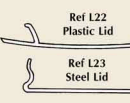

Ref L22 Plastic Lid

Ref L23 Steel Lid

- Plastic ref 22
- Steel ref 23



2) Standard Accessories

A large range of junctions and accessories are available:

All Ranges



Ref 390 Connecting sleeve (1 incl per length)



Ref 42 Terminating flange



Limited stock:  
Ref 31 Back Entry Tee



Ref 32 Top right hand



Ref 45 Internal 45° bend



Ref 34 Top left hand



Ref 37 Flanges



Ref 46 External 45° bend



Ref 33 Top square tee



Ref 38 End Cap



Ref 47 External angle



Ref 52 tapered reducer



Ref 41 Copper earth link



Ref 48 Internal angle

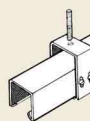

Ref 64 Trunking suspension saddle



Ref 44 Top 45° bend



Ref 62 Spring cable retainer



Ref 65 Front entry tee

C Range



Ref C21 Top gusset bend



Ref C28 Flange tee

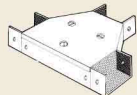

Ref C24 Top gusset tee



Ref C60 Internal gusset bend

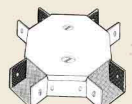

Ref C27 Top gusset cross



Ref C61 External Gusset Bend

Part references - Standard surface trunking - C type

To order quote part reference followed by Width x Height in mm, e.g. C20-2m-100x50 for a 2m length of 100mm wide by 50mm high C type surface trunking.

For multiple compartment, specify number of compartments with a "/n" where n is the number of compartments.

We will assume equal compartments unless another spacing is specified. Example C20-100x50/2 (70:30) for unequal 2 compartment trunking 100x50mm with compartments 70 and 30mm.

Note that for unequal compartment flat bends are handed and hand must be specified on ordering.

Codes for stocked items are shown below, others to order.

Size: Base X * Height Y		50*50	75*75	100*50	100*100	150*50	150*75	150*100	150*150
20-2m	C20-2m-50*50	C20-2m-75*75	C20-2m-100*50	C20-2m-100*100	C20-2m-150*50	C20-2m-150*75	C20-2m-150*100	C20-2m-150*150	
20-3m	C20-3m-50*50	C20-3m-75*75	C20-3m-100*50	C20-3m-100*100	C20-3m-150*50	C20-3m-150*75	C20-3m-150*100	C20-3m-150*150	
20L	C20L-50*50	C20L-75*75	C20L-100*50	C20L-100*100	C20L-150*50	C20L-150*75	C20L-150*100	C20L-150*150	
21	C21-50*50	C21-75*75	C21-100*50	C21-100*100	C21-150*50	C21-150*75	C21-150*100	C21-150*150	
24	C24-50*50	C24-75*75	C24-100*50	C24-100*100	C24-150*50	C24-150*75	C24-150*100	C24-150*150	
27	C27-50*50	C27-75*75	C27-100*50	C27-100*100	C27-150*50	C27-150*75	C27-150*100	C27-150*150	
38	C38-50*50	C38-75*75	C38-100*50	C38-100*100	C38-150*50	C38-150*75	C38-150*100	C38-150*150	
44	C44-50*50	C44-75*75	C44-100*50	C44-100*100	C44-150*50	C44-150*75	C44-150*100	C44-150*150	
45	C45-50*50	C45-75*75	C45-100*50	C45-100*100	C45-150*50	C45-150*75	C45-150*100	C45-150*150	
46	C46-50*50	C46-75*75	C46-100*50	C46-100*100	C46-150*50	C46-150*75	C46-150*100	C46-150*150	
60	C60-50*50	C60-75*75	C60-100*50	C60-100*100	C60-150*50	C60-150*75	C60-150*100	C60-150*150	
61	C61-50*50	C61-75*75	C61-100*50	C61-100*100	C61-150*50	C61-150*75	C61-150*100	C61-150*150	
64	C64-50*50	C64-75*75	C64-100*50	C64-100*100	C64-150*50	C64-150*75	C64-150*100	C64-150*150	
28	C28-50*50	C28-75*75	C28-100*50	C28-100*100	C28-150*50	C28-150*75	C28-150*100	C28-150*150	
31	C31-50*50	C31-75*75	C31-100*50	C31-100*100	C31-150*50	C31-150*75	C31-150*100	C31-150*150	
32	C32-50*50	C32-75*75	C32-100*50	C32-100*100	C32-150*50	C32-150*75	C32-150*100	C32-150*150	
33	C33-50*50	C33-75*75	C33-100*50	C33-100*100	C33-150*50	C33-150*75	C33-150*100	C33-150*150	
37	C37-50*50	C37-75*75	C37-100*50	C37-100*100	C37-150*50	C37-150*75	C37-150*100	C37-150*150	
42	C42-50*50	C42-75*75	C42-100*50	C42-100*100	C42-150*50	C42-150*75	C42-150*100	C42-150*150	
47	C47-50*50	C47-75*75	C47-100*50	C47-100*100	C47-150*50	C47-150*75	C47-150*100	C47-150*150	
48	C48-50*50	C48-75*75	C48-100*50	C48-100*100	C48-150*50	C48-150*75	C48-150*100	C48-150*150	
52	C52-50*50	C52-75*75	C52-100*50	C52-100*100	C52-150*50	C52-150*75	C52-150*100	C52-150*150	
65	C65-50*50	C65-75*75	C65-100*50	C65-100*100	C65-150*50	C65-150*75	C65-150*100	C65-150*150	
67	C67-50*50	C67-75*75	C67-100*50	C67-100*100	C67-150*50	C67-150*75	C67-150*100	C67-150*150	

20  
21

Part references - Lighting trunking

44	LI-B	LI-F	LI-L
45	LI-B20	LI-F20	LI-L20
46	LI-B22	LI-F22	LI-L22
20	LI-B23	LI-F23	LI-L23
31	LI-B31	LI-F31	LI-L31
32	LI-B32	LI-F32	LI-L32
33	LI-B33	LI-F33	LI-L33
34	LI-B34	LI-F34	LI-L34
37	LI-B37	LI-F37	LI-L37
38	LI-B38	LI-F38	LI-L38
41	LI-B41	LI-F41	LI-L41
42	LI-B42	LI-F42	LI-L42
44	LI-B44	LI-F44	LI-L44
45	LI-B45	LI-F45	LI-L45
46	LI-B46	LI-F46	LI-L46
47	LI-B47	LI-F47	LI-L47
48	LI-B48	LI-F48	LI-L48
62	LI-B62	LI-F62	LI-L62
64	LI-B64	LI-F64	LI-L64
65	LI-B65	LI-F65	LI-L65

20  
21

38  
44

Ref C20L trunking lid with metal turnbuckle fixings

Ref 20 trunking body available in 2 or 3 metre lengths

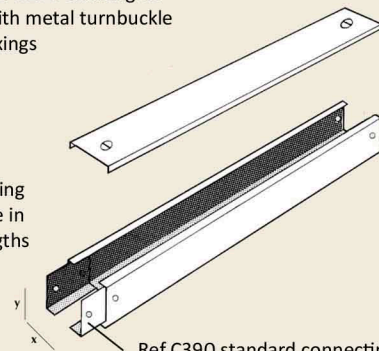

Ref C390 standard connecting sleeves. 1 pair supplied free of charge with each length of trunking. Now supplied with built in thread for increased speed of fixing

