

*Standard Finish: M06-ST-TR-SAT*

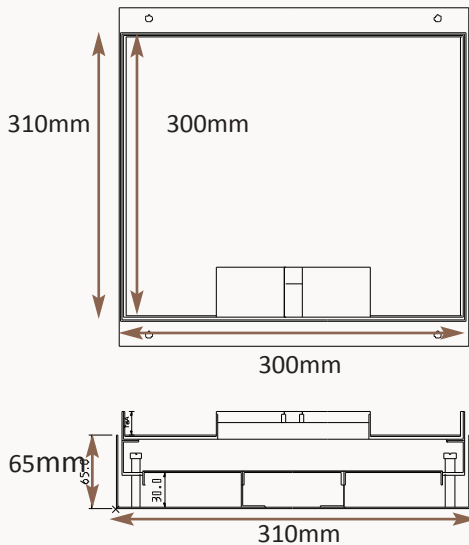

Frame size 300x300mm  
 Base box size 310x310mm  
 Lid recess - advise on order to suit floor covering  
 Base with 20 & 25mm conduit knockouts in base and sides

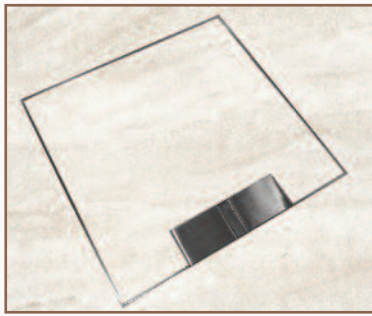
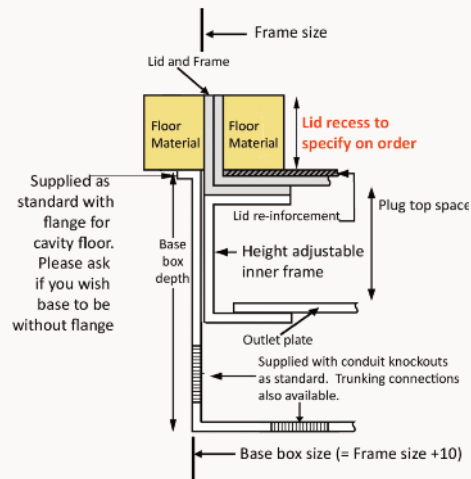
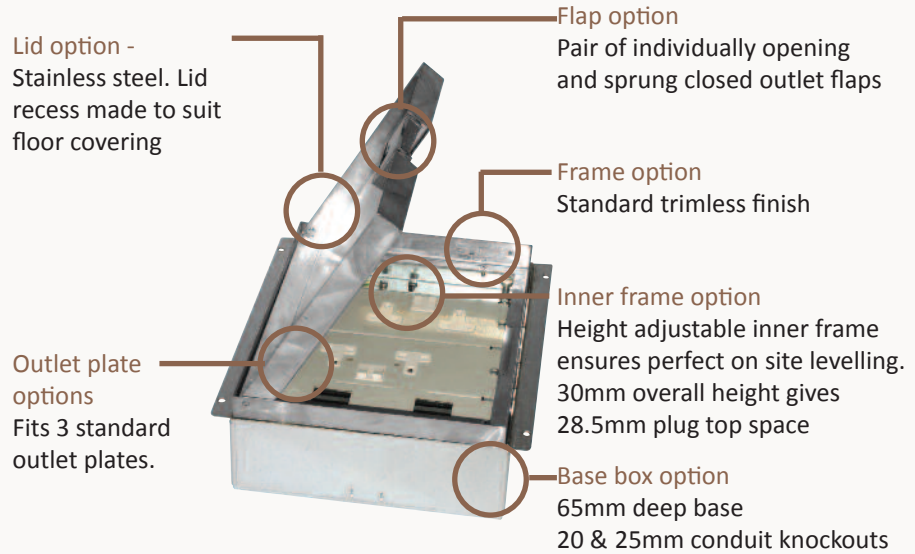

*Other Options for the M36-ST:*

- M06-ST-FL-SAT: Satin stainless steel 12.5mm trim flange, recessed lid
- M06-ST-FL-MIR: Mirror Polished stainless steel 12.5mm trim flange, recessed lid
- M06-ST-TR-MIR: Mirror Polished stainless steel trimless, recessed lid
- MIN-FLTLID: Extra to a flat instead of recessed lid
- MIN-LOCK: Extra to supply lid and frame with a cam lock
- MIN-IP65: Extra to supply the frame as sealed to IP65 when not in use
- SB70RETRO: Retro style base box fitting entirely within frame

