

Standard Finish

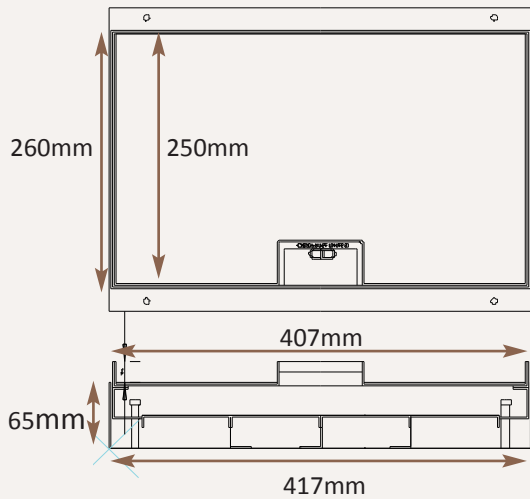

Frame size 407x250mm
 Base box size 417x260mm
 Lid recess - advise on order to suit floor covering
 Base with 20 & 25mm conduit knockouts in base and sides

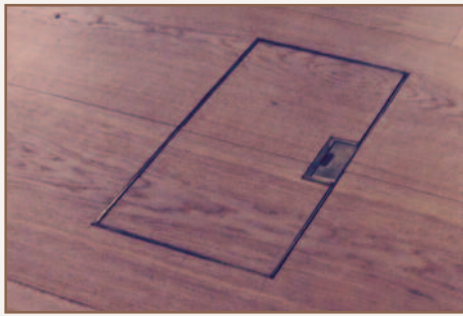
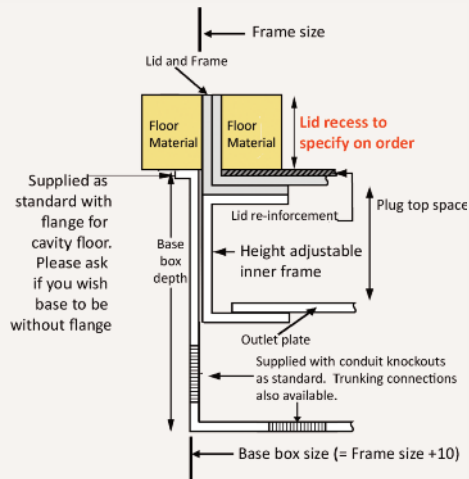
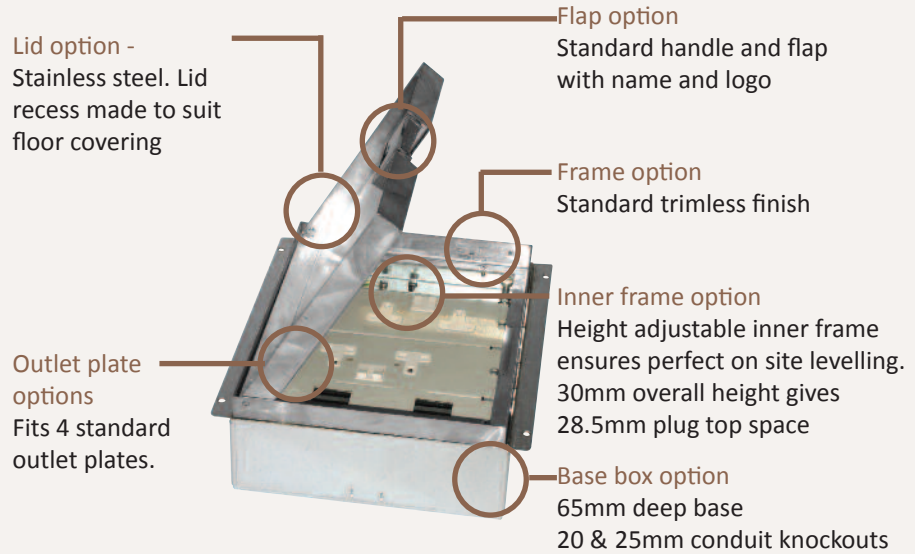

Optional Extras

- SBOX-700+ST Extra to supply box in 2mm stainless steel, with 4mm thick infill plate to withstand larger loads
- SBOX-700-IP65 Extra to box that is IP65 rated when not in use (note that the standard version is not suitable for wet washing)
- SBOX-700-FL-MIR Extra to supply lid with a mirror polished outlet flap
- SBOX-700-LOCK Extra to supply lid and frame with a cam lock
- SBOX-700-FLTLID Extra to a flat instead of recessed lid
- SBOX-MIRROR Extra to supply lid with a mirror polished flap and a Mirror polished frame (usually required only on a trim frame)
- SBOX-700-MOUS Mousehole openings to be used
- SB74RETRO Retro stlye base box fitting entirely within frame

